

# MARSDEN

USER MANUAL

## M-225

Please take time to read these  
instructions before starting  
to use the scale



# Contents

Introduction	3
Product Specification	3
Safety Instructions	4
Explanation of Graphic Symbols	5
Power Supply and Low Battery	6
Installing Batteries	6
Operation: Basic Functions	7
Operation: Advanced Functions	9
ROHS Compliance	12
EMC Guidance and Manufacturer's Declaration	13
Recommended Separation Distance	15
Error Messages	16
Manufacturer's Declaration of Conformity	19

Thank you for purchasing a Marsden professional medical scale. This is a precision Class III Weighing Instrument and considerate use will result in many years of accurate weighing.

The scale has a maximum load capacity of 250kg which must not be exceeded.

## Product Specification

Model	Marsden M-225
Accuracy Class	Class III
Capacity/Division	250kg x 100g
Weight of Scale	Approximately 18kg
Units of Measure	Kg
Function Keys	ON/ZERO/OFF, UNIT, SEND, HOLD/BMI, TARE/BSA
Stabilisation Time	1-2 Seconds
Operating Temperature	5 °C to 35°C
Power Supply	6x 1.5V AA batteries or 12V 1A adaptor (UE24WCP1 – 120100SPA)
Indicator Display	3cm display with 5 active digits
Dimensions	Chair: 400mm x 380mm Indicator: 174mm x 107.6mm x 50mm
Warranty	2 years

# Safety Instructions

Before putting the device into use, please read with care the information given in this user manual, which contains important instructions for proper installation, use and maintenance of the device.

Marsden/the manufacturer shall not be liable for damages arising from failure to heed the following instructions:

- When using electrical components under increased safety requirements, always comply with appropriate regulations.
- Inappropriate installation/use will render the warranty null and void.
- Ensure the voltage marked on the power supply unit matches your mains supply.
- This device is designed for use indoors.
- Observe the permissible ambient temperatures for use.
- The device meets the requirements for electromagnetic capability. Do not exceed the maximum values specified in the applicable standards.
- Batteries should be kept away from small children. If swallowed, promptly seek medical assistance.

If you have any problems, contact Marsden/your local dealer/your service partner.

## Cleaning

- We recommend using alcohol-based wipes or similar when cleaning the scale.
- Please do not use corrosive liquids, large amounts of water or high pressure washers.
- Always disconnect the scale from the mains power supply before cleaning.

## Maintenance

- The scale does not require any routine maintenance. However, we recommend checking the scale's accuracy at regular intervals. If any inaccuracies occur, please contact your local dealer or service partner.
- Marsden can provide service contracts for your weighing scales. For more information about Marsden service contracts call 01709 364296.

## Disposing of the Scale

- This product should not be treated as regular household waste, but should be handed in to an electrical/electronic equipment recycling centre.
- You can obtain further details from your local council, your municipal waste disposal company or from where you purchased the product.

# Explanation of Graphic Symbols

SN-21300100

Designation of the serial number of every device, applied to the device.  
(Number as an example)



“Please note the accompanying documents” or “Observe operating instructions”



Identification of manufacturer of medical product including address.

Charder Electronic Co. Ltd  
No.103 Guozhong Rd, Dali Dist,  
Taichung City 412, Taiwan (R.O.C)

Type B Applied Part.



Dispose of old appliances separately from your household waste. This product must be disposed of at a communal collection point.



Carefully read this operation manual before setup and commissioning, even if you are already familiar with Marsden scales.

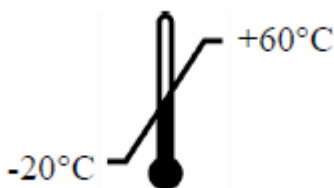

Transport and storage temperature limit indicating the upper and lower limit (transport and storage temperature on packaging).

## Power Supply & Low Battery

The indicator uses power from 6x AA batteries, or can be powered from the mains via the adaptor.

Make sure the batteries are installed in the battery box of the indicator. Alternatively, plug the adaptor (12V 1A) into the port on the side of the scale.

## Installing Batteries

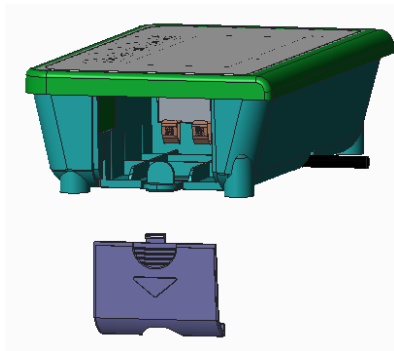

Remove the battery cover.



Remove the battery case and insert batteries, ensuring they are properly installed.

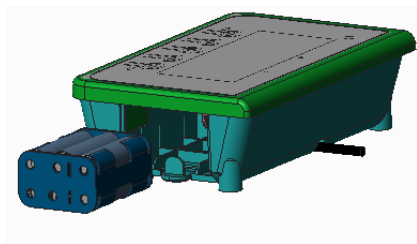

Install the battery housing.

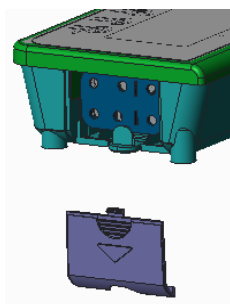

Refit the battery cover.

# Operation: Basic Functions

## Switching on the Scale

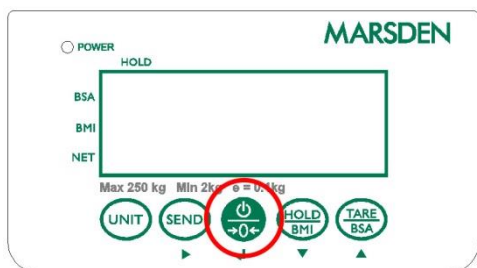

Press the ON/ZERO/OFF button firmly.

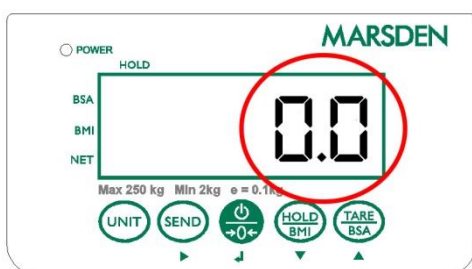

When the scale shows 0.0 on the display you are ready to start weighing.

## Switching off the Scale

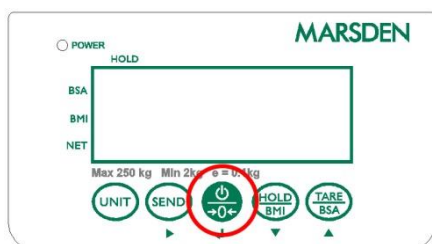

Hold the ON/ZERO/OFF button for three seconds when the scale is turned on. The scale will power down.

## Setting the Scale to Zero

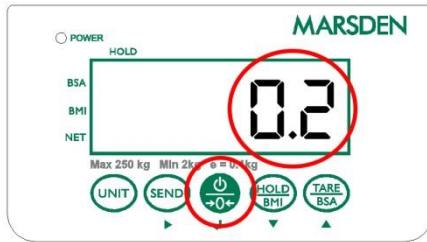

If the display shows a reading other than 0.0 when nothing is on the scale, it can be reset to zero.

Press ON/ZERO/OFF once.

The scale will return to 0.0.

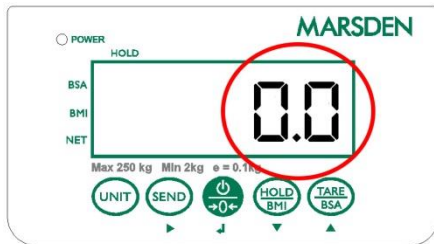



# Operation: Advanced Functions

## Hold Function

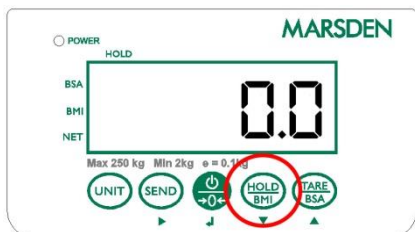

Press the HOLD/BMI button once, either whilst the patient is on the scale or before they sit on the scale.

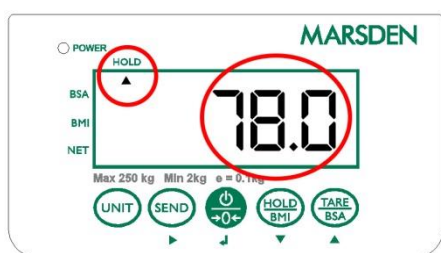

After a few seconds the scale will lock on the person's weight. When the patient leaves the scale, the weight will remain on the display.



Press HOLD/BMI again to disable the Hold function and return the scale to 0.0.

Note: If the weight reading remains on the display for more than five minutes, the Hold function will automatically disable and the display will return to 0.0. If another patient sits on the scale whilst a held weight reading is being displayed, the Hold function will be disabled.

# Body Mass Index (BMI) Function



The patient should first sit on the scale.



Hold down the HOLD/BMI button to enter BMI mode. The scale will enter height setting mode and the extreme left digit will flash.

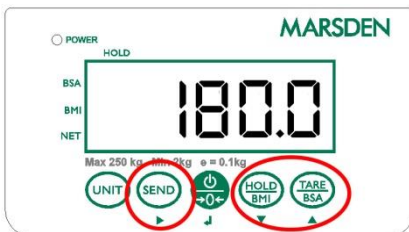

Enter the height by using the TARE/BSA button to increase the value and HOLD/BMI button to decrease the value. To move to the next digit, press SEND.



To confirm the height hold down the ON/ZERO/OFF button, after a few seconds the display will alternate between weight, height and Body Mass Index.

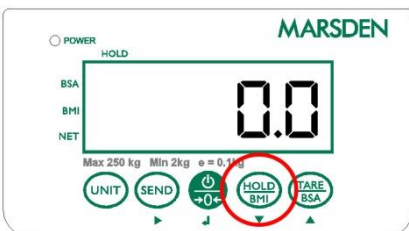

To exit BMI mode and return to normal weighing mode, hold down the HOLD/BMI button.

## Body Surface Area (BSA)



After calculating BMI, you can then calculate BSA. After going through the first four steps on the previous page steps to calculate BMI, press TARE/BSA and Body Surface Area will be displayed.

## Tare Function



Place the item/s you wish to deduct from the reading (such as a pair of shoes) on the scale and press TARE/BSA.



Remove the item/s, and the scale will show a minus reading.

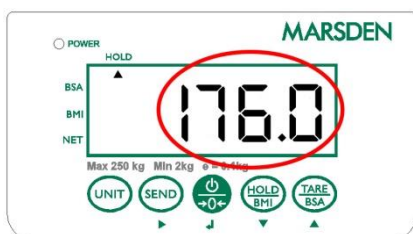

Weigh the patient as normal and the negative weight reading will be deducted from the total weight.

# ROHS Compliance



EU Directive 2011/65/EU restrict the use of the 6 substances below in the manufacture of specified types of electrical equipment.

- The product does not contain any of the restricted substances in concentrations and applications banned by the directive;
- and for components, the product is capable of being worked on at higher temperatures required by lead-free soldering.

The restricted substances and maximum allowed concentrations in the homogenous material are, by weight:

<b>Substance</b>	<b>Concentration</b>
Lead	0.1%
Mercury	0.1%
PBB (Polybrominated Biphenyls)	0.1%
PBDE (Polybrominated Diphenyl Ethers)	0.1%
Hexavalant Chromium	0.1%
Cadmium	0.01%

## Transmission Specification

Baud Rate	9600bps
Parity Check	None
Data Length	8 bit
Stop Bit	1 bit
Hardware	N/A
Data Code	ASCII

# EMC Guidance and Manufacturer's Declaration

## Guidance and manufacturer's declaration - electromagnetic emissions.

The M-225 is intended for use in the electromagnetic environment specified below. The customer or user of this scale should assure that it is used in such an environment.

<b>Emission Test</b>	<b>Compliance</b>	<b>Electromagnetic environment-guidance</b>
RF emissions CISPR 11	Group 1	This scale is suitable for use in all establishments, including domestic establishments and those directly connected to the public low-voltage power supply network that supplies buildings used for domestic purposes.
RF emissions CISPR 11	Class B	
Harmonic emissions IEC 61000-3-2	Class A	
Voltage fluctuations/flicker emissions IEC 61000-3-3	Compliance	

## Guidance and manufacturer's declaration – electromagnetic immunity.

The M-225 is intended for use in the electromagnetic environment specified below. The customer or the user of this scale should ensure that it is used in such an environment.

<b>Immunity test</b>	<b>IEC 60601 test level</b>	<b>Compliance level</b>	<b>Electromagnetic environment-guidance</b>
Electrostatic discharge(ESD) IEC 61000-4-2	± 6 kV contact ± 8 kV air	± 6 kV contact ± 8 kV air	Floors should be wood, concrete or ceramic tile. If floors are covered with synthetic material, the relative humidity should be at least 30%
Electrical fast transient/burst IEC 61000-4-4	± 2kV for power supply lines + 1kV for input/output lines	± 2kV for power supply lines Not applicable	Mains power quality should be that of a typical commercial or hospital environment.
Surge IEC 61000-4-5	± 1kV line(s) to line(s) ± 2kV line(s) to earth	± 1kV differential mode Not applicable	Mains power quality should be that of a typical commercial or hospital environment.

## Guidance and manufacturer's declaration – electromagnetic immunity.

This scale is intended for use in the electromagnetic environment specified below. The customer or the user of the scale should ensure that it is used in such an environment.

Immunity Test	IEC 60601 test level	Compliance level	Electromagnetic environment-guidance
Voltage Dips, short interruptions and voltage variations on power supply input lines IEC 61000-4-11	<5% UT(>95% dip in UT) for 0,5 cycle 40% UT(60% dip in UT) for 5 cycles 70% UT(30% dip in UT) for 25 cycles <5% UT(>95% dip in UT) for 5 s	<5% UT(>95% dip in UT) for 0,5 cycle 40% UT(60% dip in UT) for 5 cycles 70% UT(30% dip in UT) for 25 cycles <5% UT(>95% dip in UT) for 5 s	Mains power quality should be that of a typical commercial or hospital environment. If the M-225 requires continued operation during power mains interruptions, it is recommended that the M-225 be powered from an uninterruptible power supply or a battery.
Power frequency(50/60 Hz) magnetic field IEC 61000-4-8	3 A/m	3 A/m	The M-225 power frequency magnetic fields should be at levels characteristic of a typical location in a typical commercial or hospital environment.
NOTE UT is the AC mains voltage prior to application of the test level.			

## Guidance and manufacturer's declaration-electromagnetic immunity.

The M-225 is intended for use in the electromagnetic environment specified below. The customer or the user of the scale should assure that is used in such an environment.

Immunity test	IEC 60601 test level	Compliance level	Electromagnetic environment-guidance
Conducted RF IEC 61000-4-6	3 Vrms 150 KHz to 80 MHz	3 Vrms	Portable and mobile RF communications equipment should be used no closer to any part of the M-225 including cables, than the recommended separation distance calculated from the equation applicable to the frequency of the transmitter. <b>Recommended separation distance:</b> $d = 1,2 \sqrt{P}$ $d = 1,2 \sqrt{P}$ 80MHz to 800 MHz $d = 2,3 \sqrt{P}$ 800MHz to 2,5 GHz Where $P$ is the maximum output power rating of the transmitter in watts (W) according to the transmitter manufacturer and $d$ is the recommended separation distance in metres (m). Field strengths from fixed RF transmitters, as determined by an electromagnetic site survey <sup>a</sup> , should be less than the compliance level in each frequency range <sup>b</sup> . Interference may occur in the vicinity of equipment marked with the following symbol: 
Radiated RF IEC 61000-4-3	3 V/m 80MHz to 2,5 GHz	3 V/m	

NOTE1 At 80 MHz and 800 MHz, the higher frequency range applies.

NOTE2 These guidelines may not apply in all situations. Electromagnetic propagation is affected by absorption and reflection from structures, objects and people.

- a Field strengths from fixed transmitters, such as base stations for radio (cellular/cordless) telephones and land mobile radios, amateur radio, AM and FM radio broadcast and TV broadcast cannot be predicted theoretically with accuracy. To assess the electromagnetic environment due to fixed RF transmitters, an electromagnetic site survey should be considered.
- b Over the frequency range 150 kHz to 80 MHz, field strengths should be less than 3 V/m.

Recommended separation distance between portable and mobile RF communications equipment and the M-225.







Rated maximum output power of transmitter W	Separation distance according to frequency of transmitter m		
	150 kHz to 80 MHz $d = 1,2\sqrt{P}$	80 MHz to 800 MHz $d = 1,2\sqrt{P}$	800 MHz to 2,5 GHz $d = 2,3\sqrt{P}$
0.01	0.12	0.12	0.23
0.1	0.38	0.38	0.73
1	1.2	1.2	2.3
10	3.8	3.8	7.3
100	12	12	23

For transmitters rated at a maximum output power not listed above, the recommended separation distance  $d$  in meters (m) can be estimated using the equation applicable to the frequency of the transmitter, where  $p$  is the maximum output rating of the transmitter in watts (w) according to the transmitter manufacturer.

NOTE1) At 80 MHz and 800 MHz, the separation distance for the high frequency range applies.

NOTE2) These guidelines may not apply in all situations. Electromagnetic propagation is affected by absorption and reflection from structures, objects and people.

## Error Messages

<p>Low Battery The scale's AA type batteries are flat; please replace the batteries.</p>	
<p>Overload This indicates that the scale's load sensor(s) have been overloaded. Reduce the loading and retry.</p>	
<p>Counting Error The signal from the load cells is too high or too low. Please remove any weight from the scale, switch the scale off and power on again. If the scale continues to show this message, it indicates a fault with the electronics or wiring.</p>	
<p>High/Low Zero Count</p> <ol style="list-style-type: none"> <li>1. The scale is above its zero range. Please remove any weight from the scale and power on again. If the scale continues to show the error message, it indicates a fault with the electronics.</li> <li>2. The scale is below its zero range. Check there is nothing jammed underneath the scale and power on again. If the scale continues to show the error message, it indicates a fault with the electronics.</li> </ol>	 
<p>AD Error This indicates there is a fault with the scale's software and is normally caused by a fault with the PC board. Contact your local service representative.</p>	
<p>Negative weighing The weight reading is below -2kg. Press ZERO to return to 0.0.</p>	







## Manufacturer's Declaration of Conformity

This product has been manufactured in accordance with the harmonized European standards, following the provisions of the below stated directives:

	2014/31/EU Non-automatic Weighing Instruments Directive
---	---

Manufactured by:



Charder Electronic Co., Ltd.  
No.103, Guozhong Rd., Dali Dist.,  
Taichung City 412, Taiwan (R.O.C.)



Accuracy Assured

Tel: 01709 364296 / 0800 169 2775

Fax: 01709 364293

E-mail: [sales@marsdengroup.co.uk](mailto:sales@marsdengroup.co.uk)

#### Manufacturing and Distribution:

Unit 7, Centurion Business Park,

Coggin Mill Way,

Rotherham,

S60 1FB

#### Head Office:

Unit 1, Genesis Business Park,

Sheffield Road,

Rotherham

S60 1DX

[www.marsden-weighing.co.uk](http://www.marsden-weighing.co.uk)

IN-1254 (IN-8498) [80001H] REV 03/2017